

## INSTALLER'S GUIDE



Read these instructions before installation and operation



**THIS EQUIPMENT MUST BE INSTALLED AND MAINTAINED BY A SUITABLY SKILLED AND TECHNICALLY COMPETENT PERSON. ENSURE ALL POWER IS REMOVED BEFORE INSTALLATION.**

The Hush-ActiV standalone domestic fire alarm kits have been designed to reduce the incidence of false alarms in HMOs, dwellings, flats, etc., by providing a reliable, fully monitored fire detection and alarm system complete with hush (silence) and test functions.

<b>HAK/1 KIT CONTENTS</b>	1 x Hush-ActiV BS5839-6 Grade C Controller (Part No. HA508)
	1 x 230V/24V PSU (Part No. HPPSU)
	1 x ActiV Multisensor Fire Detector (Part No. C4414)
	1 x ActiV Optical Smoke Detector (Part No. C4416)
	1 x ActiV Heat Detector (Part No. C4403A2)
	3 x ActiV Detector Diode Bases (Part No. C4408D)
	1 x ActiV Base Sounder (Part No. BF431C/CC/W) c/w white lid (Part No. BF330CTLIDW) & adaptor plate (Part No. BF431QCP) 0.47µF 50V EOL capacitor, 6K8 0.25W EOL resistor
<b>HAK/2 KIT CONTENTS</b>	As HAK/1, except 2 x Smoke Detectors, 0 x Multisensor Detector
<b>HAK/3 KIT CONTENTS</b>	As HAK/1, except 2 x Multisensor Detectors, 0 x Smoke Detector

Fig.1 - Typical HAK/1 Hush-ActiV System

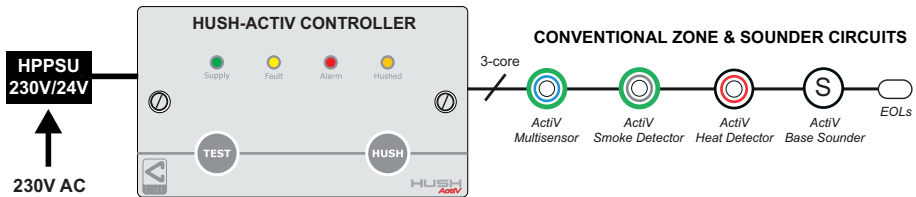

## HUSH-ACTIV TECHNICAL SPECIFICATION

<b>Max. number of ActiV conventional devices per system:</b>	16 ActiV detectors (multisensor, heat, smoke) plus 8 ActiV sounders. <b>Note:</b> See list above for devices supplied with Hush-ActiV kits.		
<b>Max. length of device circuit:</b>	200m	<b>Maximum load:</b>	100mA
<b>Operating voltage:</b>	24Vdc	<b>Quiescent current:</b>	5mA
<b>Replaceable battery (2Ah):</b>	Li-Ion rechargeable battery (C-TEC supplied only, up to 10 year life). For 16 devices, provides >72 hour standby plus 5 minute alarm (under normal use).		
<b>LED indicators:</b>	Supply (Green) LED. Lit steady when powered from the external PSU. Lit flashing when external PSU fails and the unit is only powered from the onboard battery. Fault (Yellow) LED. Lit flashing when there is device head out, wiring fault, battery fault. Alarm (Red) LED. Lit steady when there is a fire alarm. Hushed (Amber) LED. Lit steady when the unit is in a hushed (silenced) state.		
<b>Onboard beeper:</b>	Provides audible feedback when a button is pressed and in a fire / fault condition.		
<b>Control buttons:</b>	1 x TEST button & 1 x HUSH button - see 'Hush-ActiV Operation' overleaf.		
<b>Dimensions (mm):</b>	144 (W) x 84 (H) x 25 (D)	<b>Body Material:</b>	ABS polycarbonate
<b>Weight:</b>	160g	<b>IP Rating (EN 60529):</b>	IP40 (when correctly installed)
<b>Operating Temp.:</b>	-10°C to +55°C	<b>Humidity:</b>	Max. 95% RH (non-condensing)

### Advantages of a BS 5839 Part 6 Grade C system over a Grade D system

- Fault monitoring of the power supply.
- Fault monitoring of the interconnecting wiring.
- Allows residents to silence & test the system at floor level.
- Does not require mandatory replacement of devices every ten years.

## HUSH-ACTIV WIRING AND CONNECTIONS (see Fig.2 for typical connections)

All wiring must be installed in accordance with all applicable national, regional or local standards. In the UK this is BS 7671 (Wiring Regulations) and BS 5839-6 (Grade C System).

All -Ve terminals on CON1 are common -Ve. Typically, the conv. detector (ZONE) and sounder (SNDR) circuits may be wired using 3-core cable, e.g. 1mm to 1.5mm triple & earth cable. All terminals can accept cables up to 1.5mm. Alternatively, separate 2 x 2-core cable may be used.

### DIP Switch SW2 1-4 Settings:



DIP1 ON = Delay fire open collector for 2 minutes - **Default OFF**.  
DIP2 ON = Test mode triggers fire open collector output - **Default OFF**.  
DIP3 & DIP4 = For future expansion.

**PL2:** 4-way molex connector (pins left to right)

- Fire open collector
- Fault open collector
- Sounder trigger input (pin pulled low to activate)
- 0V

**PLK4:** Battery connector. To reduce battery drain, it is recommended that the battery is connected after the external 24V power is applied.

**CON1 (DC 24V):** Connects to 24V external PSU. Typically, 1mm to 1.5mm twin & earth cable may be used.

**CON1 (-ZONE+):** The conventional zone circuit connects up to 16 ActiV detectors (3 detectors supplied with each kit). Use the supplied diode bases (C4408D) with the detectors.

**CON1 (-SNDR+):** The conventional sounder circuit connects up to 8 ActiV sounders (1 sounder supplied with each kit).

**Note:** Connect the supplied EOL capacitor and EOL resistor across the terminals of the last device on each circuit to allow the wiring to be line monitored for open and short circuit faults.

Fig.2 - Typical HAK/1 Hush-ActiV Connections

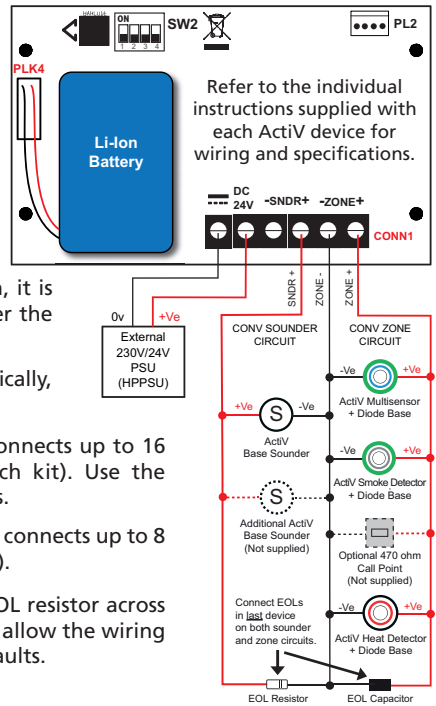

































## INSTALLATION & TESTING

This product must be installed indoors, and NOT subject to excessive dust, conductive or corrosive gases or liquids, nor subject to temperatures, input voltages, and electrical loads outside the stated operating range. Decide on where the Hush-ActiV controller is to be sited and fit a 35mm double gang back box. Also fit a 35mm double gang back box adjacent to the mains fusebox for the controller's external 230V/24VPSU (Part No. HPPSU).

The Hush-ActiV system should be tested monthly by the user by pressing the TEST button to activate the alarm devices. If any faults occur these should be reported to a competent person.

## HUSH-ACTIV OPERATION

State	State Condition		Hush-ActiV Indicators	What Happens at Hush-ActiV
1	Normal Operation		 Supply  Fault  Alarm  Hushed	<ul style="list-style-type: none"> <li>Power is applied to the detection and sounder circuits which are monitored for open and short circuit faults.</li> </ul>
2	Fire	A fire condition has been activated from a fire detector.	 Supply  Fault  Alarm  Hushed	<ul style="list-style-type: none"> <li>Beeper sounds.</li> <li>HUSH button press moves to State 3.</li> <li>Alarm sounders are activated.</li> <li>Detection zone resets every 60 seconds and requires a confirmation fire condition to stay in this state.</li> <li>If fire condition clears, system resets then automatically returns to State 1.</li> </ul>
3	HUSH button pressed when in Fire	A fire condition has been activated but then hushed (silenced). A 120 seconds hushed (silenced) period starts.	 Supply  Fault  Alarm  Hushed	<ul style="list-style-type: none"> <li>Beeper pulse rate gradually increases during the hushed period (10 seconds ⇒ 50 seconds ⇒ 90 seconds elapsed).</li> <li>HUSH button press resets the hushed timer for another 120 seconds.</li> <li>If fire condition is cleared within 120 seconds automatically returns to State 1.</li> <li>After 120 seconds have elapsed (and HUSH button NOT pressed) moves to State 2.</li> </ul>
4	HUSH button pressed when no Fire or Fault	A 15 minutes hushed (silenced) period starts to allow 'hot works' or cooking by the resident.	 Supply  Fault  Alarm  Hushed	<ul style="list-style-type: none"> <li>Beeper pulse rate gradually increases during the hushed period (10 minutes ⇒ 15 minutes elapsed).</li> <li>HUSH button press returns to State 1 after a hushed period of 0 to 12 minutes have elapsed. After a hushed period of 13 to 15 minutes have elapsed HUSH button press resets the hushed timer for an additional 15 minutes.</li> <li>After 15 minutes have elapsed automatically returns to State 1.</li> </ul>
5	General Fault	A fault condition has been activated (e.g. device fault, wiring fault, battery fault, EOL missing).	 Supply  Fault  Alarm  Hushed	<ul style="list-style-type: none"> <li>Beeper sounds.</li> <li>HUSH button press moves to State 6.</li> <li>If fault condition clears, system resets then automatically returns to State 1.</li> </ul>
6	HUSH button pressed when in Fault	A fault condition has been activated but then hushed (silenced). A 24 hour hushed (silenced) period starts.	 Supply  Fault  Alarm  Hushed	<ul style="list-style-type: none"> <li>Beeper muted.</li> <li>HUSH button press resets the hushed timer for another 24 hours.</li> <li>Detection zone resets every 60 seconds and requires a confirmation fault condition to stay in this state.</li> <li>If fault condition clears, system resets then automatically returns to State 1.</li> </ul>
7	Mains Fault	External PSU fails and the unit is powered on battery only.	 Supply  Fault  Alarm  Hushed	<ul style="list-style-type: none"> <li>Beeper sounds.</li> <li>HUSH button press moves to State 6.</li> <li>If fault condition clears, system resets then automatically returns to State 1.</li> </ul>
8	<u>To Enter Test Mode</u> Press and hold TEST button for >3 seconds.		 Supply  Fault  Alarm  Hushed	<ul style="list-style-type: none"> <li>Beeper sounds.</li> <li>Alarm sounders are activated for 5 seconds then automatically returns to State 1.</li> </ul>